

MPSW45, MPSW45A

MPSW45A is a Preferred Device

One Watt Darlington Transistors

NPN Silicon

Features

- Pb-Free Packages are Available*

MAXIMUM RATINGS

Rating	Symbol	Value	Unit
Collector – Emitter Voltage MPSW45 MPSW45A	V_{CES}	40 50	Vdc
Collector – Base Voltage MPSW45 MPSW45A	V_{CBO}	50 60	Vdc
Emitter – Base Voltage	V_{EBO}	12	Vdc
Collector Current – Continuous	I_C	1.0	Adc
Total Device Dissipation @ $T_A = 25^\circ\text{C}$ Derate above 25°C	P_D	1.0 8.0	W mW/ $^\circ\text{C}$
Total Device Dissipation @ $T_C = 25^\circ\text{C}$ Derate above 25°C	P_D	2.5 20	W mW/ $^\circ\text{C}$
Operating and Storage Junction Temperature Range	T_J, T_{stg}	-55 to +150	$^\circ\text{C}$

THERMAL CHARACTERISTICS

Characteristic	Symbol	Max	Unit
Thermal Resistance, Junction-to-Ambient	$R_{\theta JA}$	125	$^\circ\text{C}/\text{W}$
Thermal Resistance, Junction-to-Case	$R_{\theta JC}$	50	$^\circ\text{C}/\text{W}$

Maximum ratings are those values beyond which device damage can occur. Maximum ratings applied to the device are individual stress limit values (not normal operating conditions) and are not valid simultaneously. If these limits are exceeded, device functional operation is not implied, damage may occur and reliability may be affected.

*For additional information on our Pb-Free strategy and soldering details, please download the ON Semiconductor Soldering and Mounting Techniques Reference Manual, SOLDERRM/D.



ON Semiconductor®

<http://onsemi.com>

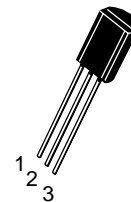
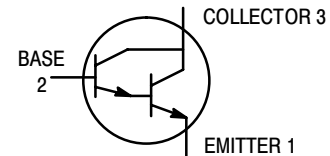

TO-92 (TO-226)
CASE 29-10
STYLE 1

MARKING DIAGRAM

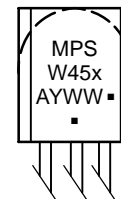

MPSW45x = Device Code
x = 45A Devices
A = Assembly Location
Y = Year
WW = Work Week
▪ = Pb-Free Package

(Note: Microdot may be in either location)

ORDERING INFORMATION

See detailed ordering and shipping information in the package dimensions section on page 5 of this data sheet.

Preferred devices are recommended choices for future use and best overall value.

MPSW45, MPSW45A

ELECTRICAL CHARACTERISTICS ($T_A = 25^\circ\text{C}$ unless otherwise noted)

Characteristic	Symbol	Min	Max	Unit	
OFF CHARACTERISTICS					
Collector – Emitter Breakdown Voltage ($I_C = 100 \mu\text{Adc}$, $V_{BE} = 0$)	MPSW45 MPSW45A	$V_{(BR)CES}$	40 50	– –	Vdc
Collector – Base Breakdown Voltage ($I_C = 100 \mu\text{Adc}$, $I_E = 0$)	MPSW45 MPSW45A	$V_{(BR)CBO}$	50 60	– –	Vdc
Emitter – Base Breakdown Voltage ($I_E = 10 \mu\text{Adc}$, $I_C = 0$)		$V_{(BR)EBO}$	12	–	Vdc
Collector Cutoff Current ($V_{CB} = 30 \text{Vdc}$, $I_E = 0$) ($V_{CB} = 40 \text{Vdc}$, $I_E = 0$)	MPSW45 MPSW45A	I_{CBO}	– –	100 100	nAdc
Emitter Cutoff Current ($V_{EB} = 10 \text{Vdc}$, $I_C = 0$)		I_{EBO}	–	100	nAdc

ON CHARACTERISTICS (Note 1)

DC Current Gain ($I_C = 200 \text{mAdc}$, $V_{CE} = 5.0 \text{Vdc}$) ($I_C = 500 \text{mAdc}$, $V_{CE} = 5.0 \text{Vdc}$) ($I_C = 1.0 \text{Adc}$, $V_{CE} = 5.0 \text{Vdc}$)	h_{FE}	25,000 15,000 4,000	150,000 – –	–
Collector – Emitter Saturation Voltage ($I_C = 1.0 \text{Adc}$, $I_B = 2.0 \text{mAdc}$)	$V_{CE(sat)}$	–	1.5	Vdc
Base – Emitter Saturation Voltage ($I_C = 1.0 \text{Adc}$, $I_B = 2.0 \text{mAdc}$)	$V_{BE(sat)}$	–	2.0	Vdc
Base – Emitter On Voltage ($I_C = 1.0 \text{Adc}$, $V_{CE} = 5.0 \text{Vdc}$)	$V_{BE(on)}$	–	2.0	Vdc

SMALL-SIGNAL CHARACTERISTICS

Current – Gain – Bandwidth Product ($I_C = 200 \text{mAdc}$, $V_{CE} = 5.0 \text{Vdc}$, $f = 100 \text{MHz}$)	f_T	100	–	MHz
Collector – Base Capacitance ($V_{CB} = 10 \text{Vdc}$, $I_E = 0$, $f = 1.0 \text{MHz}$)	C_{cb}	–	6.0	pF

1. Pulse Test: Pulse Width $\leq 300 \mu\text{s}$; Duty Cycle $\leq 2.0\%$.

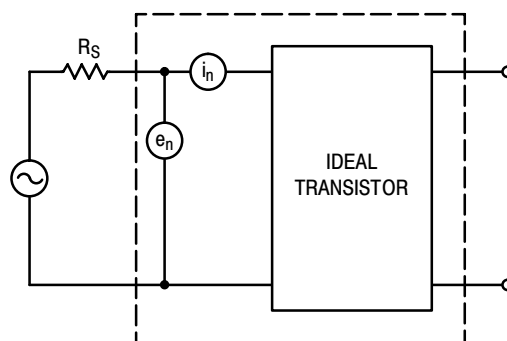

Figure 1. Transistor Noise Model

MPSW45, MPSW45A

NOISE CHARACTERISTICS

($V_{CE} = 5.0 \text{ Vdc}$, $T_A = 25^\circ\text{C}$)

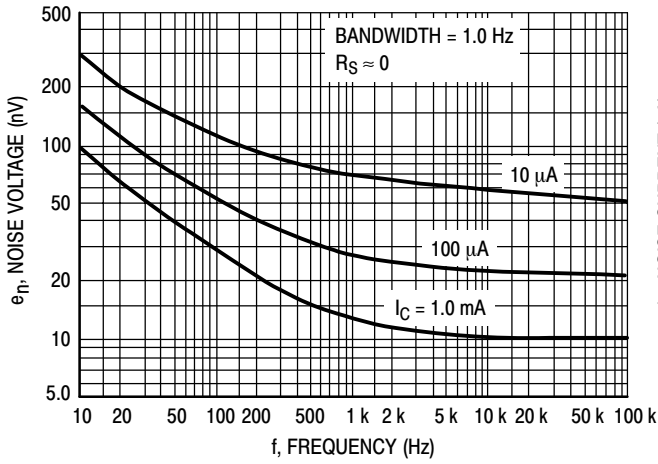

Figure 2. Noise Voltage

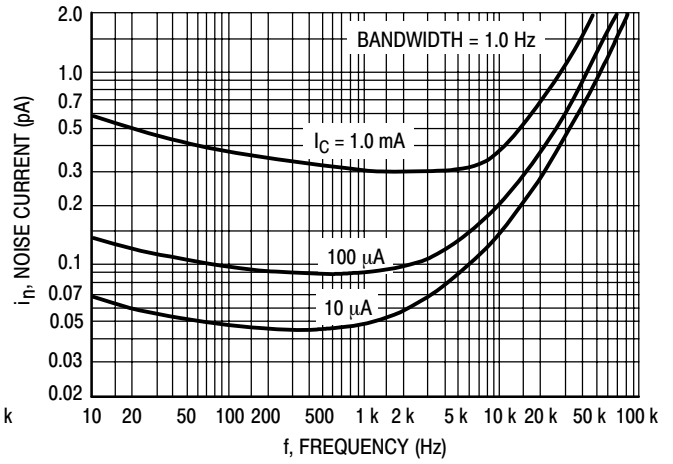

Figure 3. Noise Current

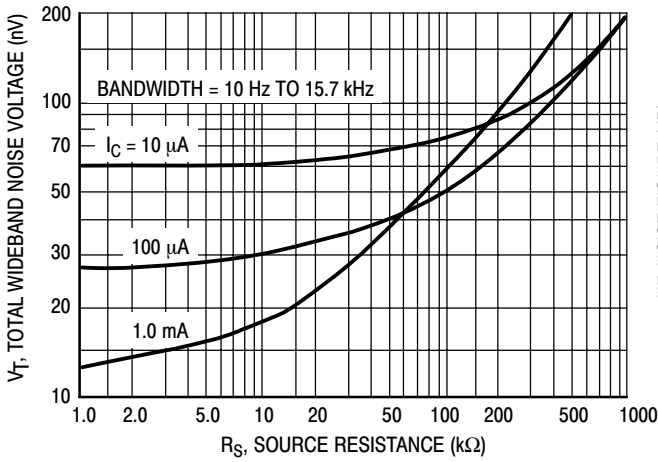

Figure 4. Total Wideband Noise Voltage

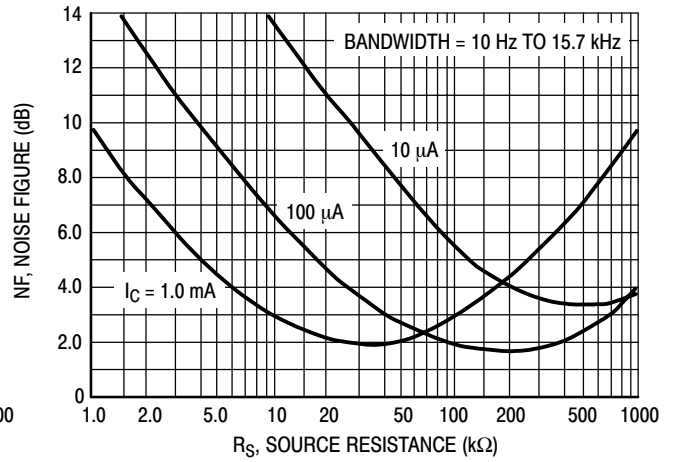

Figure 5. Wideband Noise Figure

MPSW45, MPSW45A

SMALL-SIGNAL CHARACTERISTICS

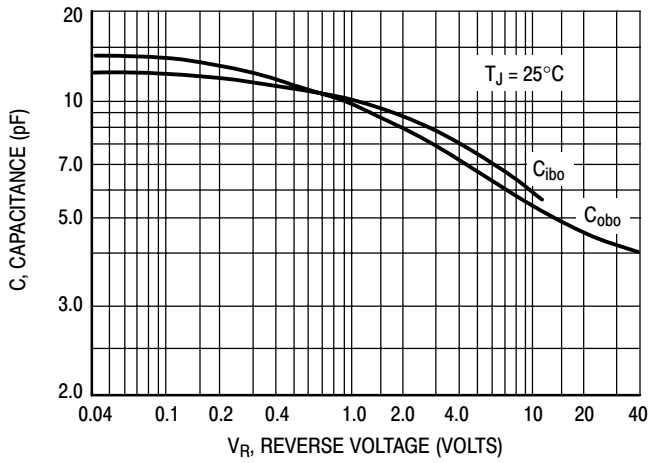

Figure 6. Capacitance

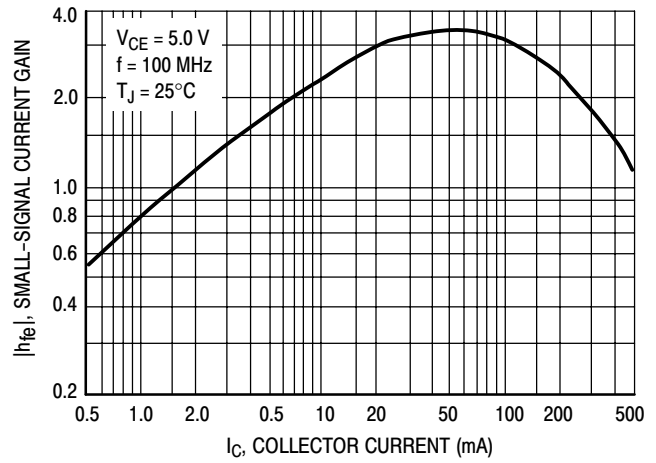

Figure 7. High Frequency Current Gain

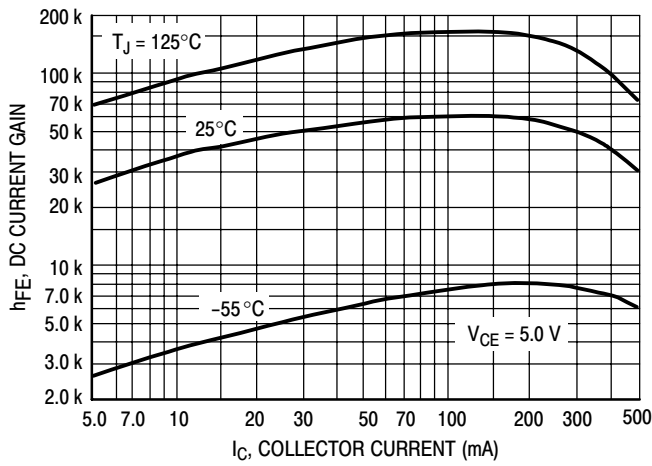

Figure 8. DC Current Gain

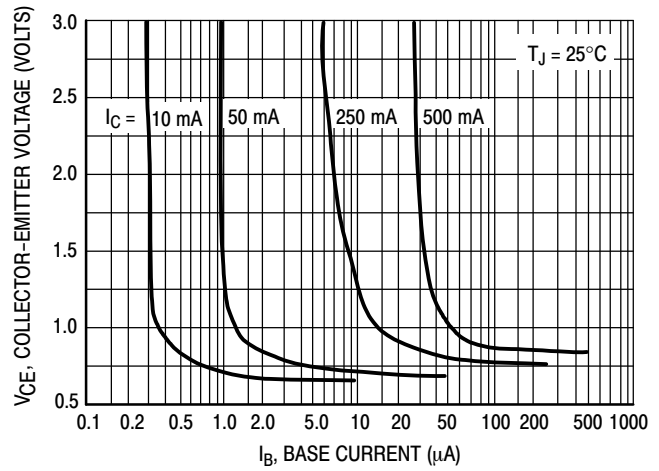

Figure 9. Collector Saturation Region

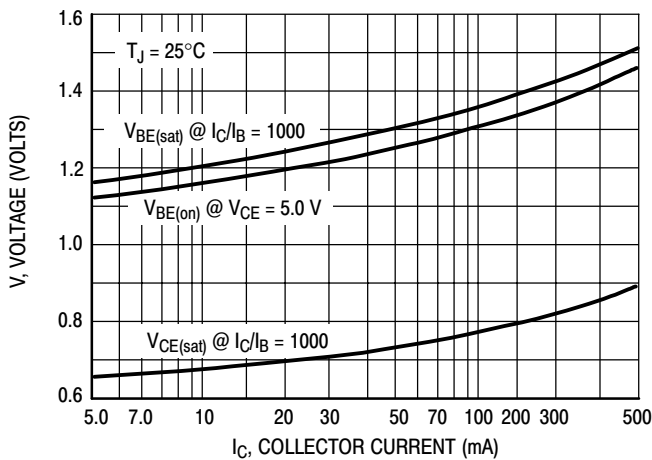

Figure 10. "On" Voltages

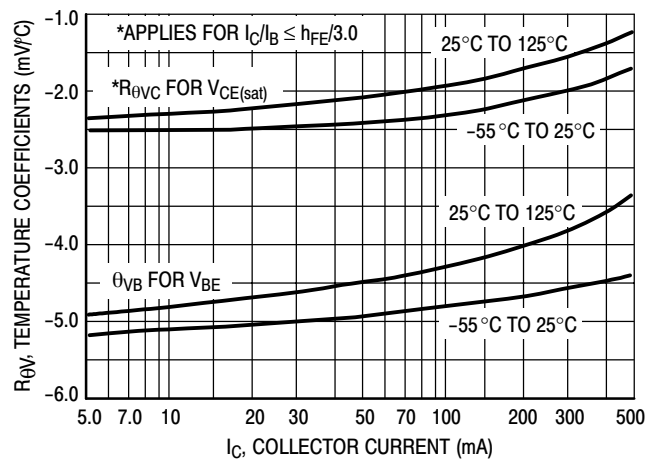

Figure 11. Temperature Coefficients

MPSW45, MPSW45A

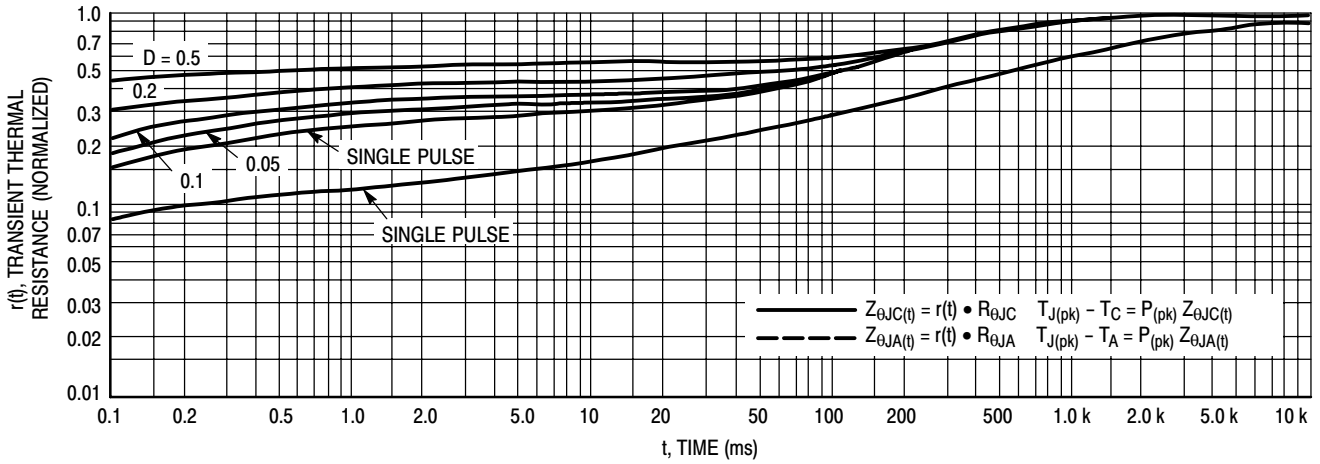

Figure 12. Thermal Response

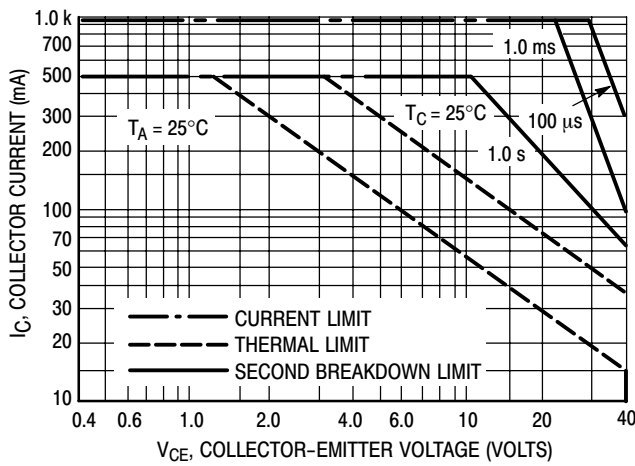
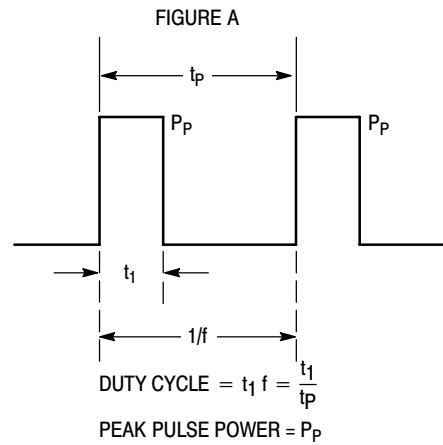

Figure 13. Active Region Safe Operating Area



Design Note: Use of Transient Thermal Resistance Data

ORDERING INFORMATION

Device	Package	Shipping†
MPSW45	TO-92	5,000 Units / Box
MPSW45G	TO-92 (Pb-Free)	5,000 Units / Box
MPSW45RLRE	TO-92	2,000 / Tape & Reel
MPSW45RLREG	TO-92 (Pb-Free)	2,000 / Tape & Reel
MPSW45A	TO-92	5,000 Units / Box
MPSW45AG	TO-92 (Pb-Free)	5,000 Units / Box
MPSW45ARLRA	TO-92	2,000 / Tape & Reel
MPSW45ARLRAG	TO-92 (Pb-Free)	2,000 / Tape & Reel
MPSW45AZL1	TO-92	2,000 / Ammo Pack
MPSW45AZL1G	TO-92 (Pb-Free)	2,000 / Ammo Pack

†For information on tape and reel specifications, including part orientation and tape sizes, please refer to our Tape and Reel Packaging Specifications Brochure, BRD8011/D.

MPSW45, MPSW45A

PACKAGE DIMENSIONS

TO-92 (TO-226)
CASE 29-10
ISSUE AL

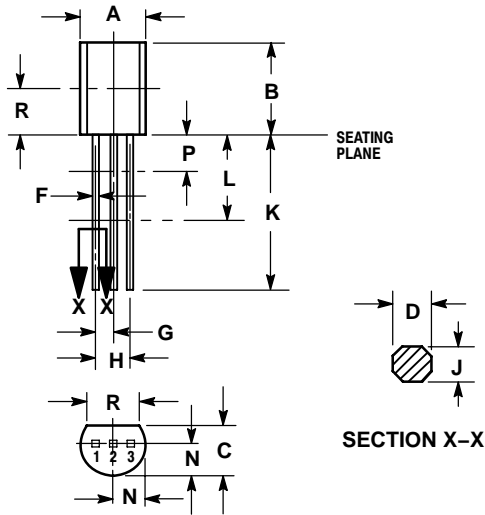

NOTES:

1. DIMENSIONING AND TOLERANCING PER ANSI Y14.5M, 1982.
2. CONTROLLING DIMENSION: INCH.
3. CONTOUR OF PACKAGE BEYOND DIMENSION R IS UNCONTROLLED.
4. DIMENSION F APPLIES BETWEEN P AND L. DIMENSIONS D AND J APPLY BETWEEN L AND K MINIMUM. LEAD DIMENSION IS UNCONTROLLED IN P AND BEYOND DIMENSION K MINIMUM.

DIM	INCHES		MILLIMETERS	
	MIN	MAX	MIN	MAX
A	0.175	0.205	4.44	5.21
B	0.290	0.310	7.37	7.87
C	0.125	0.165	3.18	4.19
D	0.018	0.021	0.457	0.533
F	0.016	0.019	0.407	0.482
G	0.045	0.055	1.15	1.39
H	0.095	0.105	2.42	2.66
J	0.018	0.024	0.46	0.61
K	0.500	---	12.70	---
L	0.250	---	6.35	---
N	0.080	0.105	2.04	2.66
P	---	0.100	---	2.54
R	0.135	---	3.43	---

STYLE 1:

- PIN 1. EMITTER
- BASE
- COLLECTOR

ON Semiconductor and are registered trademarks of Semiconductor Components Industries, LLC (SCILLC). SCILLC reserves the right to make changes without further notice to any products herein. SCILLC makes no warranty, representation or guarantee regarding the suitability of its products for any particular purpose, nor does SCILLC assume any liability arising out of the application or use of any product or circuit, and specifically disclaims any and all liability, including without limitation special, consequential or incidental damages. "Typical" parameters which may be provided in SCILLC data sheets and/or specifications can and do vary in different applications and actual performance may vary over time. All operating parameters, including "Typicals" must be validated for each customer application by customer's technical experts. SCILLC does not convey any license under its patent rights nor the rights of others. SCILLC products are not designed, intended, or authorized for use as components in systems intended for surgical implant into the body, or other applications intended to support or sustain life, or for any other application in which the failure of the SCILLC product could create a situation where personal injury or death may occur. Should Buyer purchase or use SCILLC products for any such unintended or unauthorized application, Buyer shall indemnify and hold SCILLC and its officers, employees, subsidiaries, affiliates, and distributors harmless against all claims, costs, damages, and expenses, and reasonable attorney fees arising out of, directly or indirectly, any claim of personal injury or death associated with such unintended or unauthorized use, even if such claim alleges that SCILLC was negligent regarding the design or manufacture of the part. SCILLC is an Equal Opportunity/Affirmative Action Employer. This literature is subject to all applicable copyright laws and is not for resale in any manner.

PUBLICATION ORDERING INFORMATION

LITERATURE FULFILLMENT:
Literature Distribution Center for ON Semiconductor
P.O. Box 61312, Phoenix, Arizona 85082-1312 USA
Phone: 480-829-7710 or 800-344-3860 Toll Free USA/Canada
Fax: 480-829-7709 or 800-344-3867 Toll Free USA/Canada
Email: orderlit@onsemi.com

N. American Technical Support: 800-282-9855 Toll Free
USA/Canada

Japan: ON Semiconductor, Japan Customer Focus Center
2-9-1 Kamimeguro, Meguro-ku, Tokyo, Japan 153-0051
Phone: 81-3-5773-3850

ON Semiconductor Website: <http://onsemi.com>

Order Literature: <http://www.onsemi.com/litorder>

For additional information, please contact your local Sales Representative.